

**ALL-PURPOSE 8"  
TWO-WAY COMPACT  
LOUDSPEAKER  
SYSTEM**



# CA - 8 T



The Klipsch CA-8T compact full range system is perfect for higher power professional applications where flexible mounting and extended range are required, including everything needed for fast and easy distributed sound installations. Equally at home indoors or out, in foreground or background, higher SPL applications, the CA-8T's appearance and Klipsch fidelity fit into residential, business or recreational environments equally well.

The UV- and weather-resistant ABS enclosure includes an internal multi-tap transformer with switchable direct 8 ohm bypass, simplifying hookup to any type of sound system. The C-bracket assembly attaches to the enclosure's integral stainless steel threaded studs with oversized knobs, ensuring a positive position-lock and rapid "no-pain" installation. External attachment to the built-in security retainer provides an extra measure of safety, protecting against unexpected damage or removal.

The CA-8T includes a high power 8" extended range low-frequency driver and a 1" titanium diaphragm compression driver on a molded Tractrix Horn. The 90° x 60° horn and driver assembly allows repositioning by 90° for selectable pattern control.

The compact dual port bass reflex loudspeaker system can handle 100 watts continuous power for an AES sensitivity of 96dB and a maximum output of 113dB SPL.

Paintable and available in black or white finishes, the ABS enclosure features corrosion- and rust-resistant stainless steel hardware and a removable aluminum powder-coated grille, ensuring maintenance-free service in any environment or application.

Whether indoors or out, the Klipsch CA-8T is the good looking, great sounding full-range solution for installed high-fidelity sound.

- Compact UV and weather-resistant ABS enclosure
- Adjustable pattern 90° x 60° Tractrix® Horn
- Internal 60W multi-tap transformer with direct 8 ohm bypass
- Continuous high power handling of 100 watts
- White or black enclosure paintable to match decor
- 96dB sensitivity, 113dB maximum output (1 meter)
- 11.125" x 16.375" x 11.75" and 17 lbs.

## Specifications

FREQUENCY RESPONSE <sup>1</sup>	64Hz -19kHz±4dB
POWER HANDLING <sup>2</sup>	100 W (21V)
MAXIMUM CONTINUOUS OUTPUT <sup>3</sup>	113dB
SENSITIVITY (2.83 V/1M) <sup>4</sup>	96dB
TRANSFORMER TAPS	70V: 60W, 30W, 15W 100V: 60W, 30W Thru Position: 8 ohms
HORIZONTAL COVERAGE	60°±40 2500Hz-20kHz
VERTICAL COVERAGE	80°±40 1300Hz-20kHz
DIRECTIVITY	8±2dB 1300Hz-20kHz
NOMINAL IMPEDANCE	8 ohms nominal (4.2 min @ 175 Hz)
CROSSOVER FREQUENCY	2kHz
COMPONENTS	One K-1111-A 8" low frequency driver One K-118-A 1" titanium diaphragm compression driver
INPUT CONNECTORS	5-way binding posts
ENCLOSURE MATERIAL	All-weather ABS plastic
HEIGHT	11.125" (28.26cm)
WIDTH	16.375" (41.59cm)
DEPTH	11.75" (29.85cm)
WEIGHT	17 lbs. (7.72kg)
SHIPPING WEIGHT	44 lbs. (19.98kg)
FINISHES	White or Black
ACCESSORIES	C-Bracket (included), CASecurity Kit

<sup>1</sup>3M, Half-space anechoic

<sup>2</sup>AES Standard, continuous pink noise 50Hz-10kHz, 6dB peaks

<sup>3</sup>Calculated at 1M at power handling power input

<sup>4</sup>SPL at 1M, half-space anechoic with 2.83V input

# CA-8T

## COMPACT 8" TWO-WAY SPEAKER SYSTEM

Frequency Response

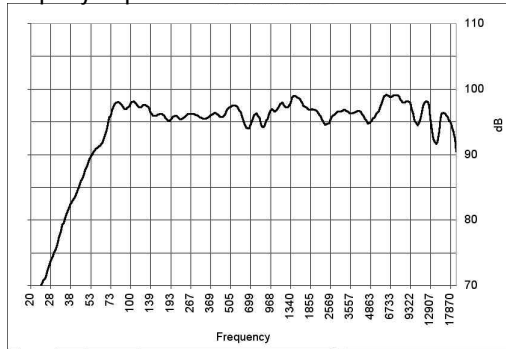

Impedance

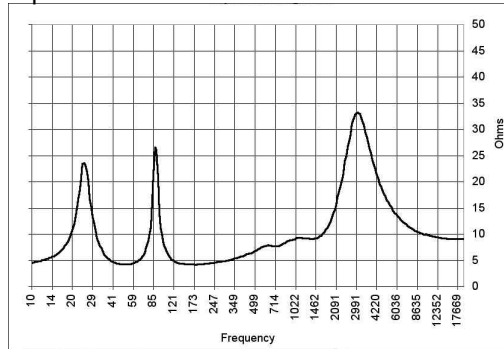

Horizontal Off-Axis Transfer Function

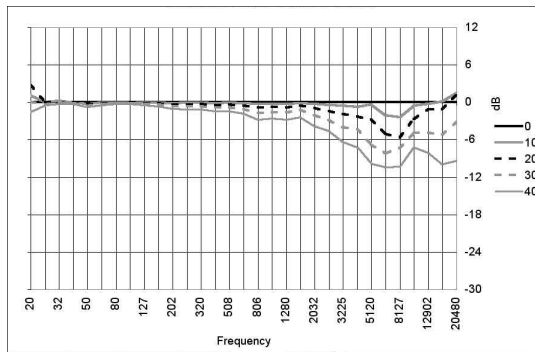

Directivity Index

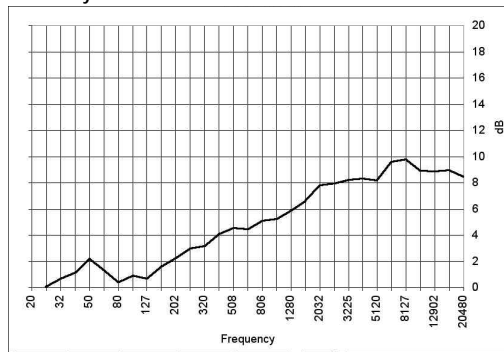

Horizontal Coverage (-6dB)

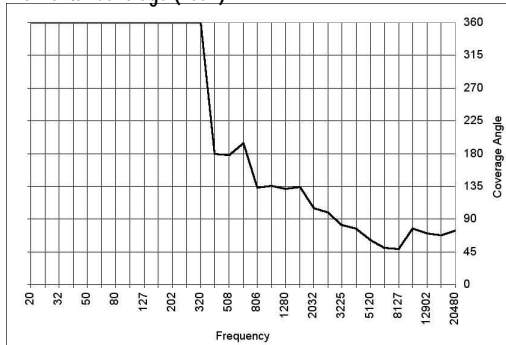

Vertical Coverage (-6dB)



Vertical Off-Axis Transfer Function UP

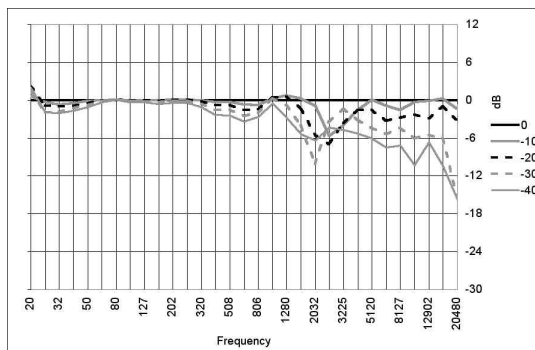

Vertical Off-Axis Function DOWN

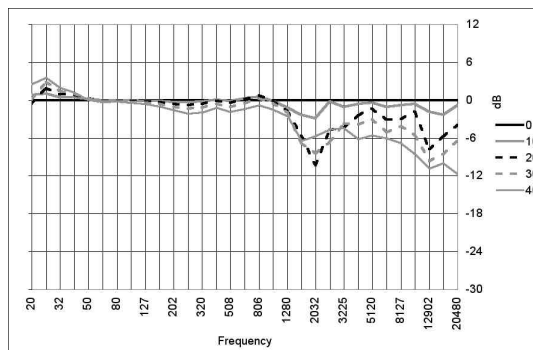

# Vertical $\frac{1}{3}$ Octave Polars

# Horizontal $\frac{1}{3}$ Octave Polars

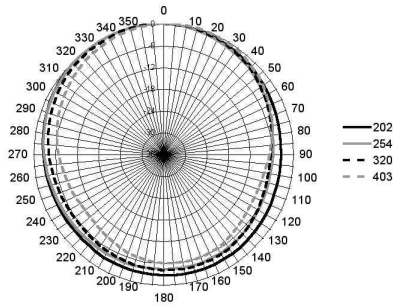

- 202
- 254
- - 320
- - 403

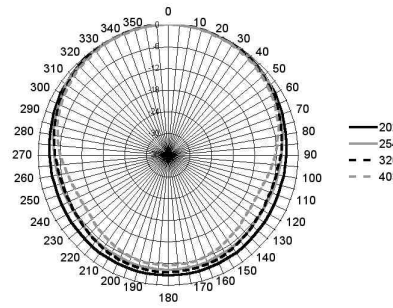

- 202
- 254
- - 320
- - 403

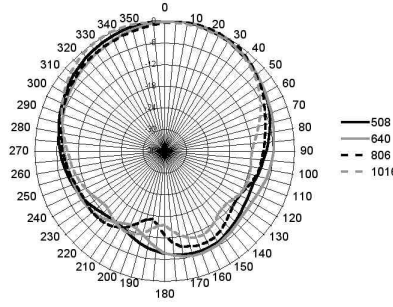

- 508
- 640
- - 806
- - 1016

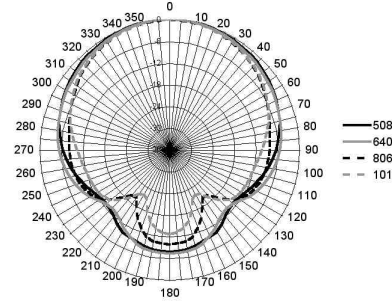

- 508
- 640
- - 806
- - 1016

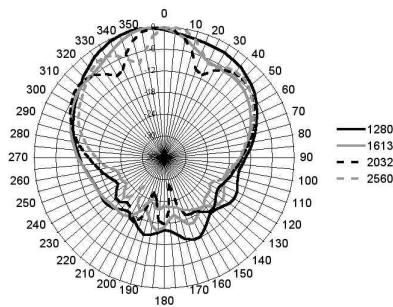

- 1280
- 1613
- - 2032
- - 2560

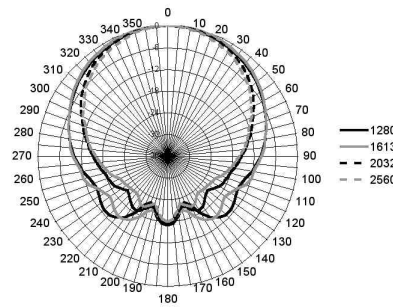

- 1280
- 1613
- - 2032
- - 2560

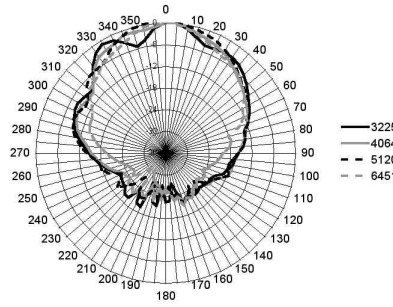

- 3225
- 4064
- - 5120
- - 6451

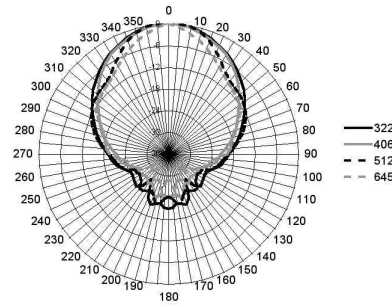

- 3225
- 4064
- - 5120
- - 6451

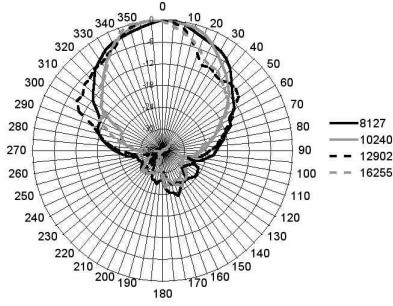

- 8127
- 10240
- - 12902
- - 16255

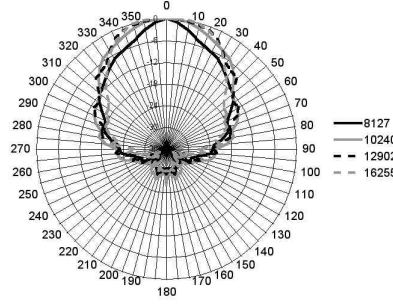

- 8127
- 10240
- - 12902
- - 16255

# Architectural Specifications

The CA-8T all-purpose two-way compact loudspeaker system shall include a 8" (20.32cm) K-1111-A weather-resistant low frequency driver and a 1" (2.54cm) K-118-A titanium diaphragm high frequency compression driver mounted on a molded Tractrix Horn. Signal shall be provided to the transducers via a passive internal frequency dividing network, with a 2kHz crossover frequency. The enclosure tuning shall be dual port bass reflex.

Frequency response shall be 64Hz to 19kHz,  $\pm 4$ dB, with the -10dB down point at 45Hz, measured at 1 meter, half space anechoic. The dispersion angle shall be 90° x 60° nominal (refer to graph). Sensitivity shall be 96dB SPL, measured at 1 meter, half space anechoic, with a 2.83V input. Power handling shall be 100 watts (21V), to AES standards, continuous pink noise, 50Hz to 10kHz, 6dB peaks. Calculated maximum continuous output at 1 meter shall be 113dB SPL. Nominal impedance shall be 8 ohms, with a 4.2 ohm minimum at 175Hz. Full-range connections shall be made via 5-way binding posts.

A removable powder-coated aluminum grille shall be provided for protection of the transducers from tampering or damage. The enclosure shall be of UV- and weather-resistant ABS plastic, available in black or white, with dimensions of 11.125" (28.26cm) high by 16.375" (41.59cm) wide by 11.75" (29.85cm) deep. Net weight shall be 17 lbs. (7.72kg). Mounting shall be via protruding stainless steel threaded studs on the side enclosure panels, mating to large external knobs for positive attachment to the C-shaped mounting bracket (included).

The system shall be a Klipsch CA-8T loudspeaker.

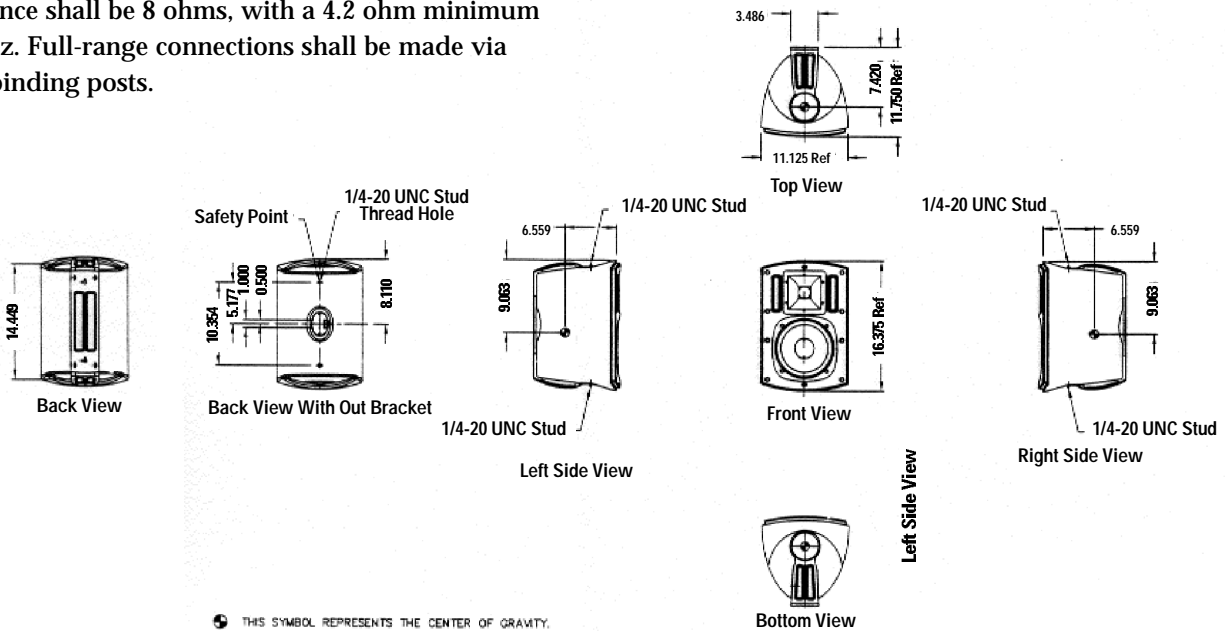

3502 Woodview Trace, Suite 200 • Indianapolis, IN 46268  
 137 County Road 278 • Hope, AR USA 71801  
 1-888-600-5776 • www.klipsch.com